

TFSH002- SOLID LEVER HANDLES

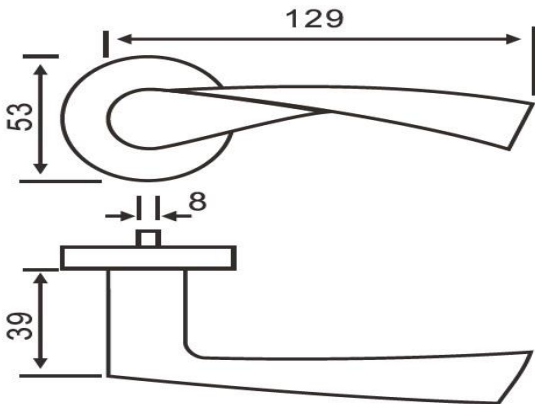

- Stainless steel Solid lever handle grade- SS304 /316
- Spring Assisted Chassis
- 52mm push on rose with 8mm projection
- Supplied with 52mm escutcheons prepared for Euro-profile cylinders
- 8mm x 8mm square spindle
- Rosette Type :Clip on/ Thread On type
- Supplied with suitable back to back fixing screws
- Add suffix S for same design on Square rose and escutcheons